

(24x) M8x14

(24x) M8

(24x)

(24x)

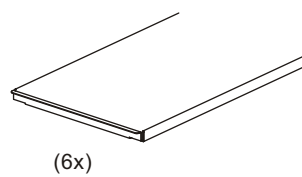
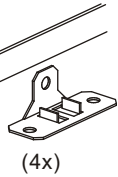
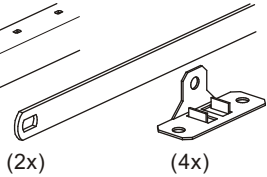
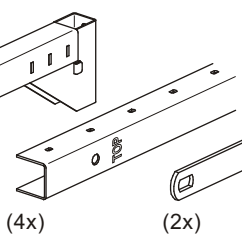
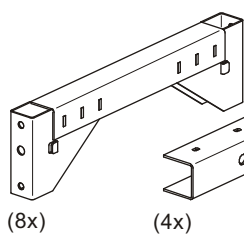

A



Budget Grund 2500

1.

2500

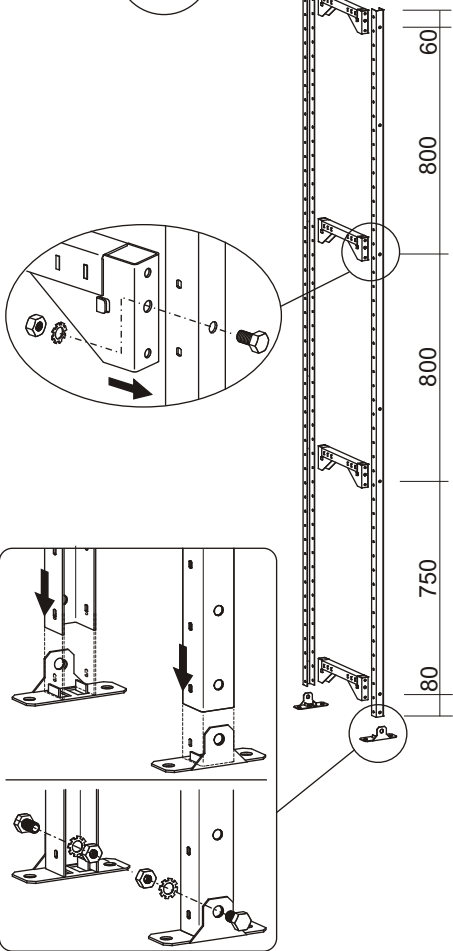

2.

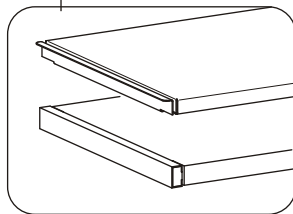
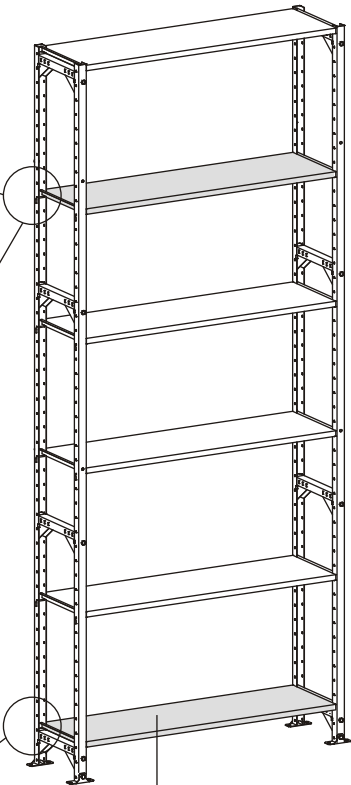
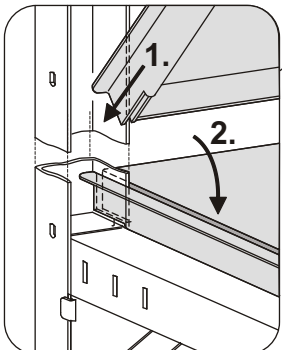
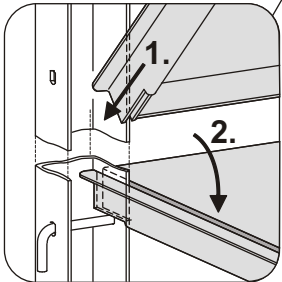
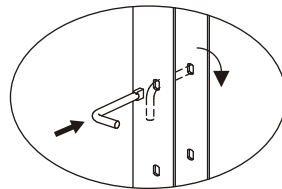

3.

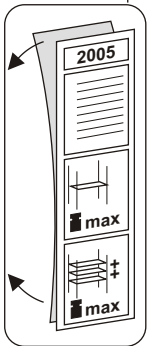
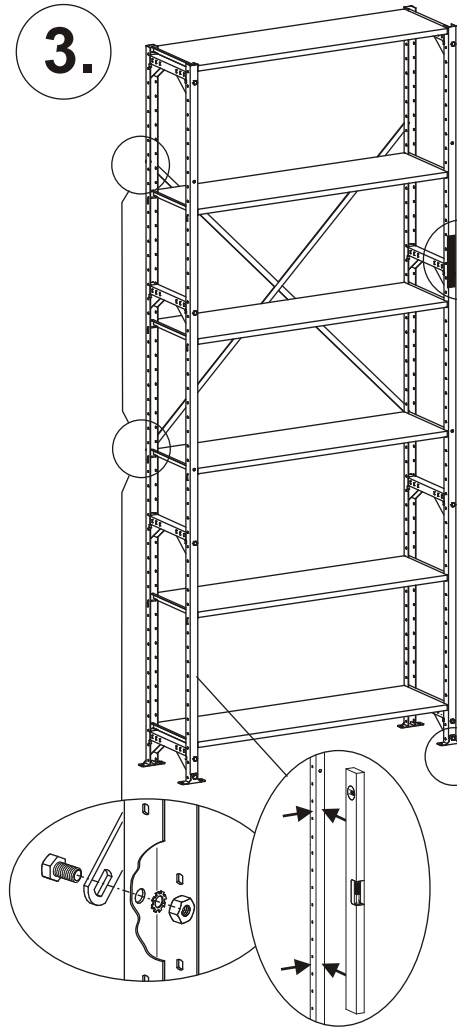

4.

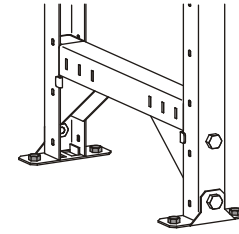
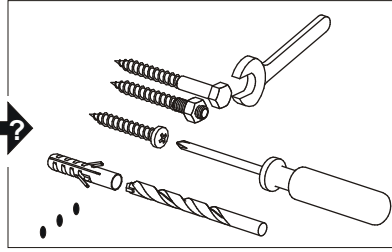
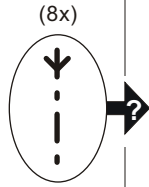
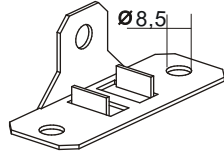
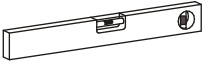
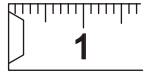

Budget Grund 2500

4.

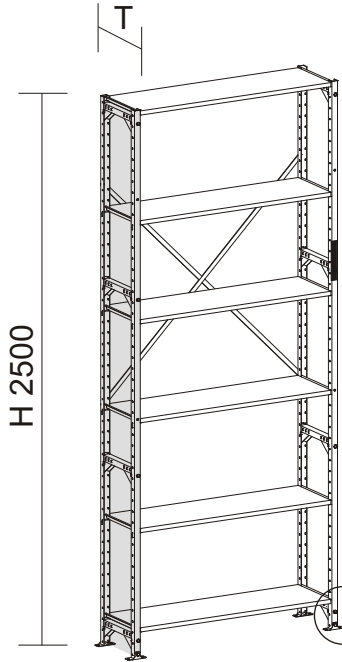

H:T ≥ 5:1

T =
300
400
500

H:T < 5:1

T =
600
700
800
1000